

PHILIPS

Soundbar

8000 series

TAB8805

Quick Start Guide



Register your product and get support at
www.philips.com/support



- EN** Before using your Product, read all accompanying safety information
- SQ** Para se ta përdorni produktin, lexoni të gjitha informacionet e dhëna lidhur me sigurinë
- AR** قبل استخدام المنتج الخاص بك ، اقرأ جميع معلومات السلامة المصاحبة
- BS** Prije upotrebe proizvoda, pročitajte sve prateće sigurnosne informacije
- BG** Преди да използвате продукта, прочетете цялата съпътстваща информация за безопасност
- HR** Prije uporabe proizvoda pročitajte sve popratne sigurnosne informacije
- CS** Před použitím produktu si přečtěte všechny doprovodné bezpečnostní informace
- DA** For du bruger dit produkt, skal du læse alle ledsagende sikkerhedsoplysninger
- NL** Lees alle bijbehorende veiligheidsinformatie voordat u uw product gebruikt
- ET** Enne oma toote kasutamist lugege kaasasolev ohutusteave hoolikalt läbi.
- FI** Ennen tuotteen käyttöä, lue kaikki mukana toimitetut turvaohjeet
- FR** Avant d'utiliser votre produit, lisez toutes les informations de sécurité qui l'accompagnent.
- DE** Bevor Sie Ihr Produkt verwenden, lesen Sie alle begleitenden Sicherheitsinformationen
- EL** Πριν χρησιμοποιήσετε το προϊόν σας, διαβάστε όλες τις συνοδευτικές πληροφορίες ασφαλείας
- HU** A termék használatá elött olvassa el az összes mellékelt biztonsági utasítást
- IT** Prima di utilizzare il prodotto, leggere tutte le informazioni di sicurezza allegate
- KK** Өнімдi пайдалану алдындагы бүгкi iлеспе кауыпсыздык туралы ақпаратты оқып шығыңыз
- LV** Pirms izstrādājuma lietošanas izlasiet visu pievienoto drošības informāciju
- LT** Prieš pradėdami naudoti produktą, perskaitykite visa pridedamą saugos informaciją.
- MK** Пред да го користите производот, прочитајте ги сите придружни безбедносни информации
- ME** Prije upotrebe Proizvoda, pročitajte sve priložene sigurnosne informacije
- NO** For du bruker produktet, må du lese all medfølgende sikkerhetsinformasjon
- PL** Przed użyciem urządzenia zapoznaj się ze wszystkimi informacjami dotyczącymi bezpieczeństwa
- PT** Antes de utilizar o produto, leia todas as informações de segurança que o acompanham
- RO** Înainte de a utiliza produsul nostru, citiți toate informațiile de siguranță alăturate.
- RU** Перед использованием изделия прочтите прилагаемую информацию по безопасности.
- SR** Пред upotrebe proizvoda, pročitajte sve prateće bezbednosne informacije
- SK** Pred použitím Vašho produktu si prečítajte všetky priložené bezpečnostné informácie
- SL** Pred uporabo tega izdelka obvezno preberite navodila proizvajalca.
- ES** Antes de usar el producto, lea toda la información de seguridad que lo acompaña
- SV** Läs all medföljande säkerhetsinformation innan du använder din produkt
- TR** Ürününüzü kullanmadan önce, beraberindeki tüm güvenlik bilgilerinizi okuyun.
- UK** Перед використанням пристрою прочитайте всю інформацію з техніки безпеки, що додається
- MS** Sebelum menggunakan Produk anda, baca semua maklumat keselamatan yang dilampirkan
- ID** Sebelum menggunakan produk, baca semua informasi petunjuk keamanan

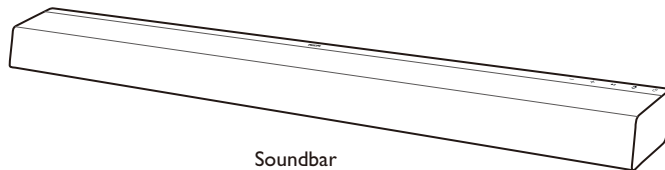

Soundbar



Remote Control

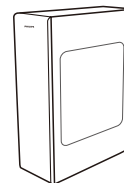

Wireless Subwoofer

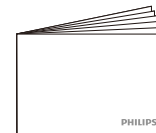

Quick start guide

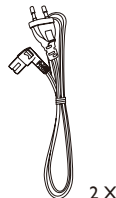

Power Cord * 2 X

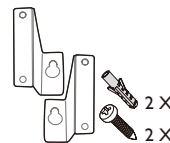

Wall Bracket
Rub Cover
Screws (for wall) 2 X

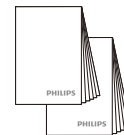

Warranty Card
Safety Sheet

* Power cord quantity and plug type vary by regions.



- EN** Position the SoundBar / Wall mount the SoundBar (optional)
SQ Poziciononi SoundBar / Montoni SoundBar në mur (opsionale)
AR قم بتثبيت الصوتية الصوتية/قم بتعليق الصوتية على الجدار (اختياري)
BS Postavite SoundBar / zidni nosač za SoundBar (opcija)
BG Позиционирайте SoundBar системата/ монтирайте SoundBar системата на стената (по избор)
HR Postavljanje SoundBar/zidni nosač za SoundBar (opcionalno)
CS Umístění zařízení SoundBar / připevnění zařízení Soundbar na stěnu (volitelně)
DA Sætte den SoundBar / Vægmontere den SoundBar (valgfrit)
NL Plaats de SoundBar / Bevestig de SoundBar aan de muur (optioneel)
ET SoundBari asukoht / SoundBari seinakinnitus (valikuline)
FI Aseta äänipalkki kohdalleen / seinäkiinnitys äänipalkki (valinnainen)
FR Placement / Montage mural (en option) de la barre de son
DE Positionierung der SoundBar / Wandmontage der SoundBar (optional)
EL Τοποθέτηση της Μπάρας ήχου / Στήριξη της Μπάρας ήχου στον τοίχο (προαιρετικό)
HU A hangoszlop elhelyezése / A hangoszlop falra szerelése (opcionális)
IT Posizionamento della SoundBar / Montaggio della SoundBar a parete (opzionale)
KK Саундбарды орналастыруу / саундбарды кабыргага бекитүү (миндетти емес)
LV Novietojiet SoundBar/sienas stiprinājuma SoundBar (pēc izvēles)
LT „SoundBar“ tvirtinimo padėtis / „SoundBar“ sienos laikiklis (pasirinktinai)
MK Поставање на Саундбар / Монтирање на ѕид на Саундбар (опционално)
ME Postavite zvučnik SoundBar / Okačite na zid zvučnik SoundBar (opciono)
NO Posisjoner SoundBar/veggmonter SoundBar (valgfritt)
PL Ustaw soundbar / zamontuj soundbar na ścianie (opcjonalnie)
PT Posicione a SoundBar/instale na parede a SoundBar (opcional)
RO Poziționați SoundBar-ul/montați pe perete SoundBar-ul (opțional)
RU Установите звуковую панель / закрепите звуковую панель на стене (опция).
SR Postavite saundbar / postavite saundbar na zid (po izboru)
SK Umiestnenie SoundBaru/Montáž SoundBaru na stenu (voliteľné)
SL Postavitev SoundBar / Stenska montaža SoundBar (po izbori)
ES Colocar la barra de sonido/Montar la barra de sonido en la pared (opcional)
SV Placera din SoundBar/Väggmontera din SoundBar (valfritt)
TR SoundBar'ı Yerleştirme / SoundBar'ı Duvara monte etme (isteğe bağlı)
UK Розташування звукової панелі / настінне кріплення звукової панелі (необов'язково)
MS Menetapkan kedudukan Bar Bunyi/ Lepakkan Bar Bunyi ke dinding (pilihan)
ID Posisikan SoundBar/Pasang SoundBar di tembok (opsional)

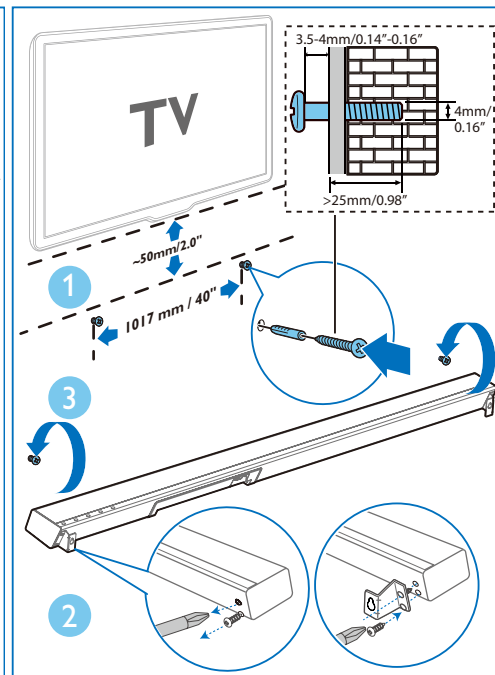
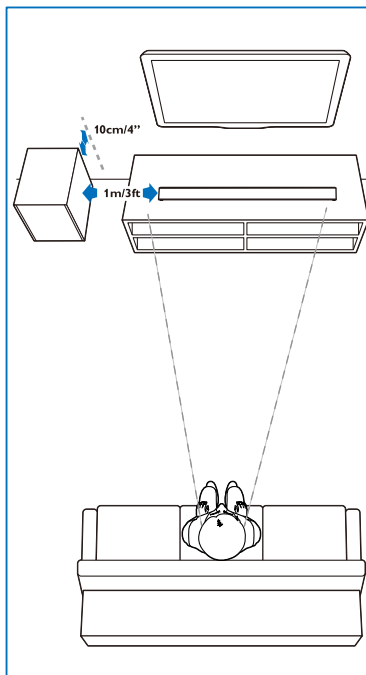

Suggested wall mounting height

You are suggested to install the TV first before wall mounting the soundbar.

With a TV preinstalled, wall mount the soundbar 50mm/2.0" in distance from the bottom of the TV.

If you wall mount the soundbar first, Drill 2 parallel holes (Ø 3-8 mm each according to wall type) in the wall. The distance between the holes should be 1017mm / 40".

2

- EN** Connect the SoundBar
- SQ** Lidhni SoundBar
- AR** قم بتوصيل العارضة الصوتية
- BS** Spojite SoundBar
- BG** Съвържете SoundBar системата
- HR** Sojite SoundBar
- CS** Připojení zařízení Soundbar
- DA** Tilslut den SoundBar
- NL** Sluit de SoundBar aan
- ET** SoundBari ühendamine
- FI** Yhdistä äänipalkki
- FR** Connexion de la barre de son
- DE** Anschließen der SoundBar
- EL** Σύνδεση της Μπάρας ήχου
- HU** A hangoszlop csatlakoztatása
- IT** Collegamento della SoundBar
- KK** Саундбарды косу
- LV** Pievienojiet SoundBar
- LT** „SoundBar“ prijungimas
- MK** Повежете го Саундбар
- ME** Povežite zvučnik SoundBar
- NO** Koble til SoundBar
- PL** Podłącz soundbar
- PT** Ligue a SoundBar
- RO** Conectați SoundBar-ul
- RU** Подключите звуковую панель
- SR** Повежите саундбар
- SK** Zapojenie SoundBaru
- SL** Povezava SoundBar
- ES** Conectar la barra de sonido
- SV** Anslut din SoundBar
- TR** SoundBar'ı bağlayın
- UK** Під'єднання звукової панелі
- MS** Sambungkan Bar Bunyi
- ID** Hubungkan SoundBar

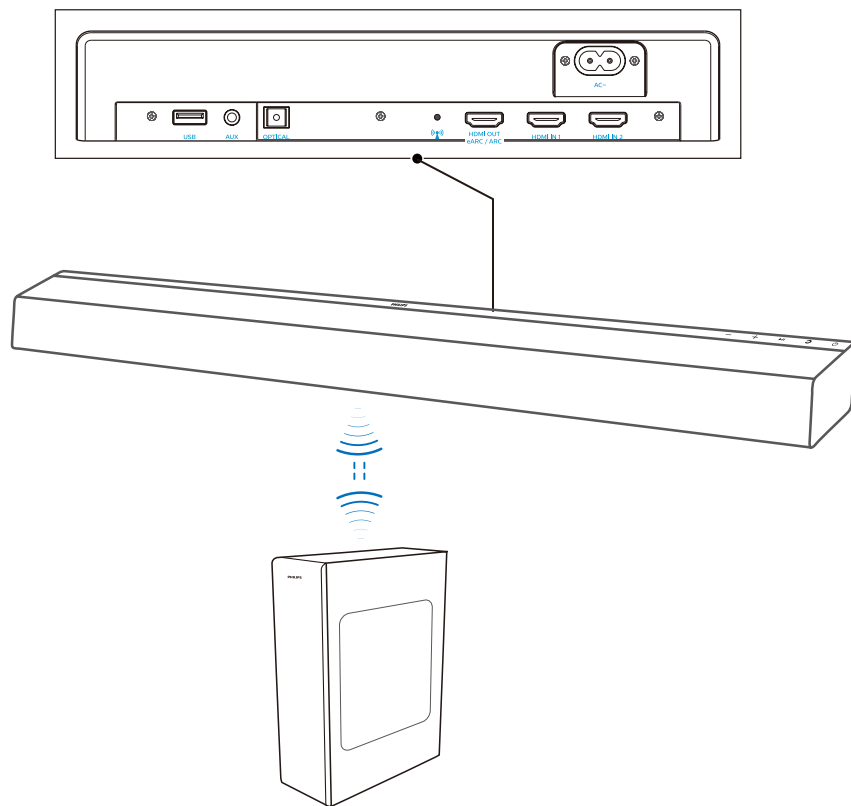

3

- EN** Hear audio from TV in one of the following ways
- SQ** Dëgjoni zërin nga televizori në një prej mënyrave të mëposhtme
- AR** سماع الصوت من التلفزيون بإحدى الطرق التالية
- BS** Slušajte zvuk s TV-a na jedan od sljedećih načina
- BG** Слушайте звука от телевизора по един от следните начини
- HR** Slušajte zvuk s televizora na jedan od sljedećih načina
- CS** Poslouchejte zvuk z TV jedním z následujících způsobů
- DA** Hør lyd fra tv på en af følgende måder
- NL** Luister naar geluid van van de tv op een van de volgende manieren
- ET** Kuulake oma teleri heli ühel järgnevest viisidest
- FI** Kuule ääni TV-stä yhdellä seuraavista tavoista
- FR** Écoutez le son du téléviseur par l'un de ces moyens
- DE** Hören Sie den Fernsehton auf eine der folgenden Arten
- EL** Μπορείτε να ακούσετε ήχο από την τηλεόραση με έναν από τους παρακάτω τρόπους
- HU** Hallgassa a tv hangját az alábbi módok egyikének használatával
- IT** Ascolto dell'audio dalla TV in uno dei seguenti modi
- KK** Теледидар аудиосын келеси жолдардын биреумен тыңдау
- LV** Klausieties audio no TV vienā no šiem veidiem
- LT** Klausykites TV garso vienu iš toliau aprašytų būdų
- MK** Слушајте аудио од ТВ на еден од следивне начини
- ME** Slušajte zvuk sa televizora na jedan od sljedećih načina
- NO** Hør lyd fra TV-en på en av følgende måter
- PL** Odtwarzaj dźwięk z telewizora w jeden z następujących sposobów
- PT** Ouça o áudio da televisão de uma das seguintes formas
- RO** Ascultați audio de la TV în una dintre următoarele metode
- RU** Прослушивайте аудиозаписи с ТВ одним из следующих способов.
- SR** Slušajte zvuk sa TV-a na jedan od sledećih načina
- SK** Počúvanie zvuuku z TV jedným z nasledujúcich spôsobov
- SL** Televizijski zvok lahko poslušate na enega izmed naslednjih načinov:
- ES** Escuche el audio del televisor de una de las formas siguientes
- SV** Hör ljud från TV:n på ett av följande sätt
- TR** Aşağıdaki yollarla birliyle TV'den ses dinleyin.
- UK** Слухайте аудіо з телевізора одним із таких способів
- MS** Mendengar audio daripada TV menerusi salah satu cara yang berikut
- ID** Nikmati audio TV dengan salah satu cara berikut

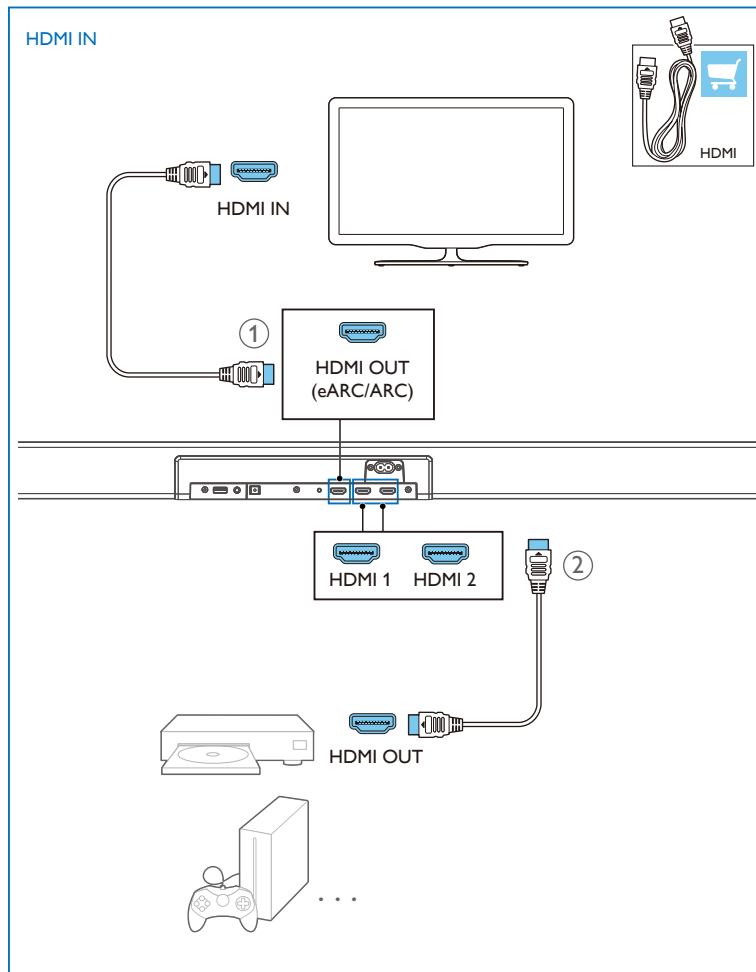

HDMI eARC/ARC

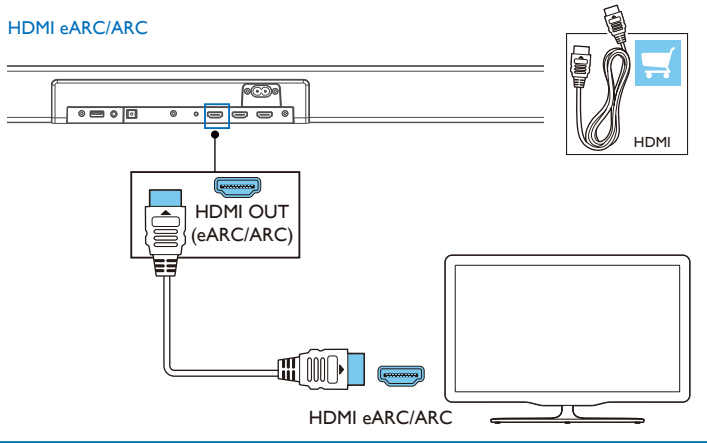

AUX

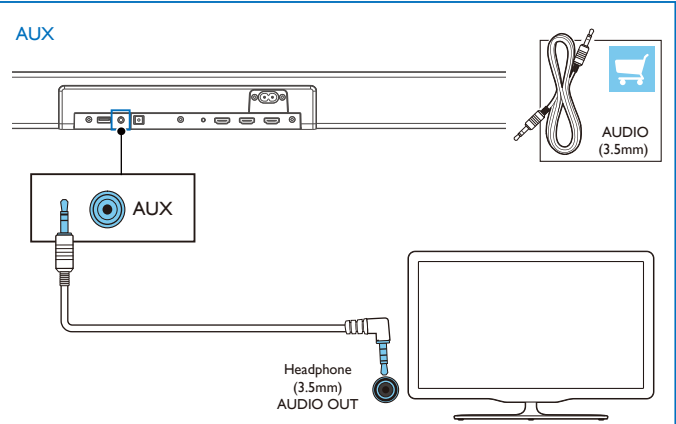

OPTICAL

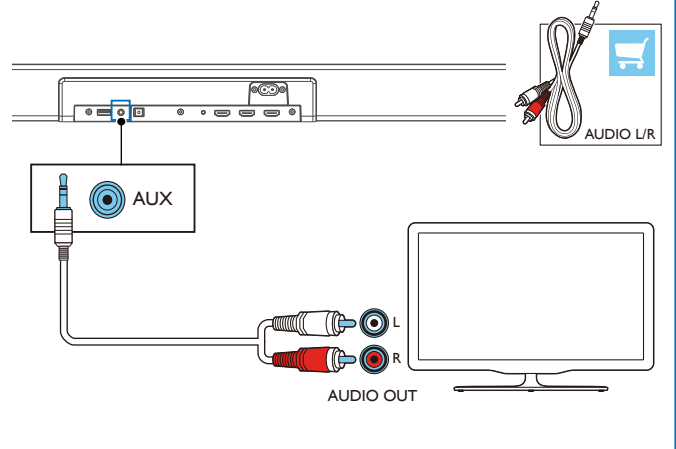
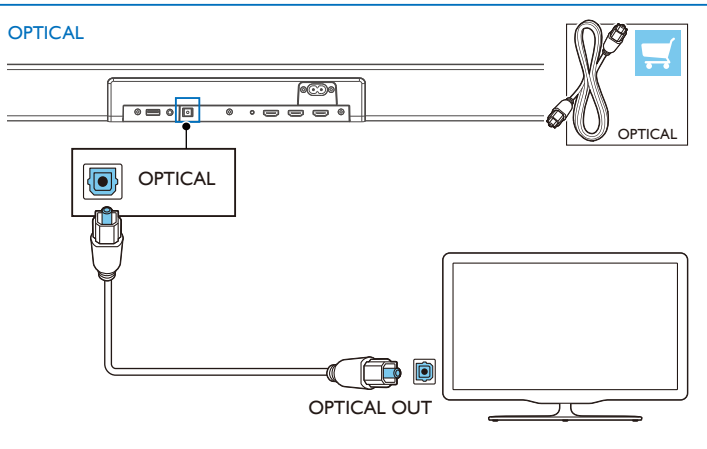

4

- EN** Switch on the SoundBar
- SQ** Ndizeni SoundBar
- AR** قم بتشغيل العارضة الصوتية
- BS** Uključite SoundBar
- BG** Включете SoundBar системата
- HR** Uključite SoundBar
- CS** Zapněte zařizení Soundbar
- DA** Tænd for den SoundBar
- NL** Schakel de SoundBar in
- ET** Lülitage SoundBar sisse
- FI** Kytke äänipalkki päälle
- FR** Allumez la barre de son
- DE** Schalten Sie die SoundBar ein
- EL** Ανάψτε τη Μπάρα ήχου
- HU** A hangoszlop bekapcsolása
- IT** Accensione della SoundBar
- KK** Саундбарды косу
- LV** Ieslēdziet SoundBar
- LT** „SoundBar” įjungimas
- MK** Вклучете го Саундбар
- ME** Uključite zvučnik SoundBar
- NO** Slå på SoundBar
- PL** Włącz soundbar
- PT** Ligue a Soundbar
- RO** Porniți SoundBar-ul
- RU** Переключитесь на звуковую панель.
- SR** Укључите саундбар
- SK** Zapnúťte SoundBaru
- SL** Vkljop SoundBar
- ES** Encender la barra de sonido
- SV** Slå på din SoundBar
- TR** SoundBar'ı açın
- UK** Увімкніть звукову панель
- MS** Hidupkan Bar Bunyi
- ID** Nyalakan SoundBar

1

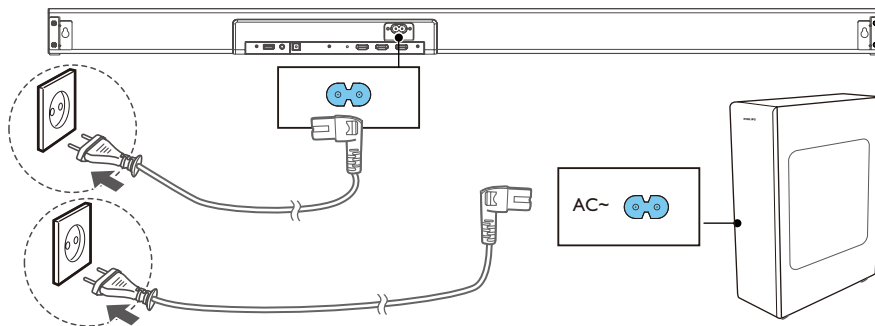

2

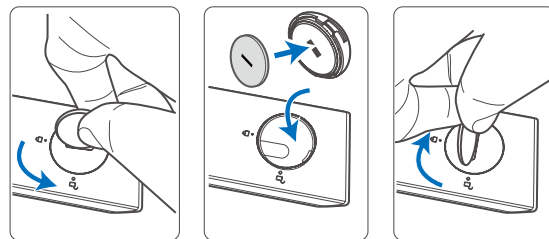
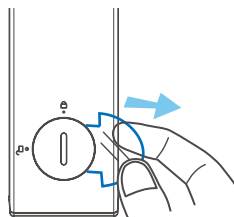

3

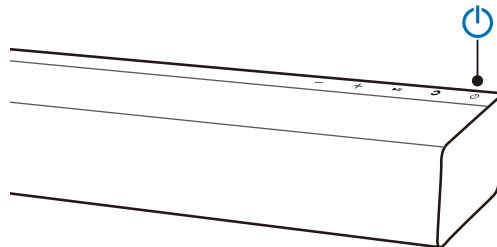
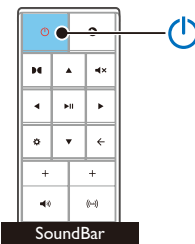

5

- EN** Select the correct audio source
- SQ** Zgjidhni burimin e duhur të audios
- AR** حدد مصدر الصوت الصحيح
- BS** Odaberite odgovarajući izvor zvuka
- BG** Изберете правилния източник на звук
- HR** Odaberite odgovarajući izvor zvuka
- CS** Vyberte správný zdroj zvuku
- DA** Vælg den rigtige lydkilde
- NL** Selecteer de juiste geluidsbron
- ET** Valige õige heliallikas
- FI** Valitse oikea äänilähde
- FR** Sélectionnez la source audio appropriée
- DE** Wählen Sie die richtige Audioquelle
- EL** Επιλέξτε τη σωστή πηγή ήχου
- HU** A megfelelő hangforrás kiválasztása
- IT** Selezione della sorgente audio corretta
- KK** Дүрүс аудио көзүн таңдау
- LV** Atlasiet pareizo audio avotu
- LT** Pasirinkite teisingą garso šaltinį
- MK** Изберете го точниот аудио извор
- ME** Odaberite ispravan izvor zvuka
- NO** Velg riktig lydkilde
- PL** Wybierz prawidłowe źródło dźwięku
- PT** Seleccione a fonte de áudio correta
- RO** Selectați sursa audio corectă
- RU** Выберите нужный аудиосource.
- SR** Изаберите одговарајући извор звука
- SK** Výber správneho audio zdroja
- SL** Izberite pravi vir zvoka
- ES** Seleccionar la fuente de audio correcta
- SV** Välj den korrekta ljudkällan
- TR** Doğru ses kaynağını seçin.
- UK** Виберіть відповідне джерело звуку
- MS** Pilih sumber audio yang betul
- ID** Pilih sumber audio yang benar

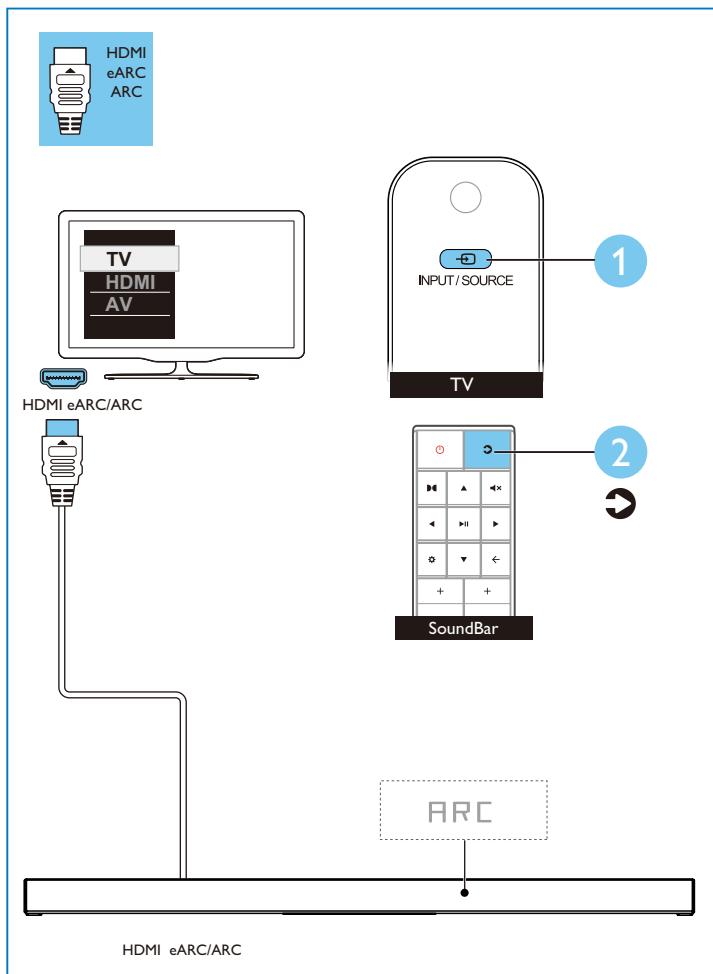

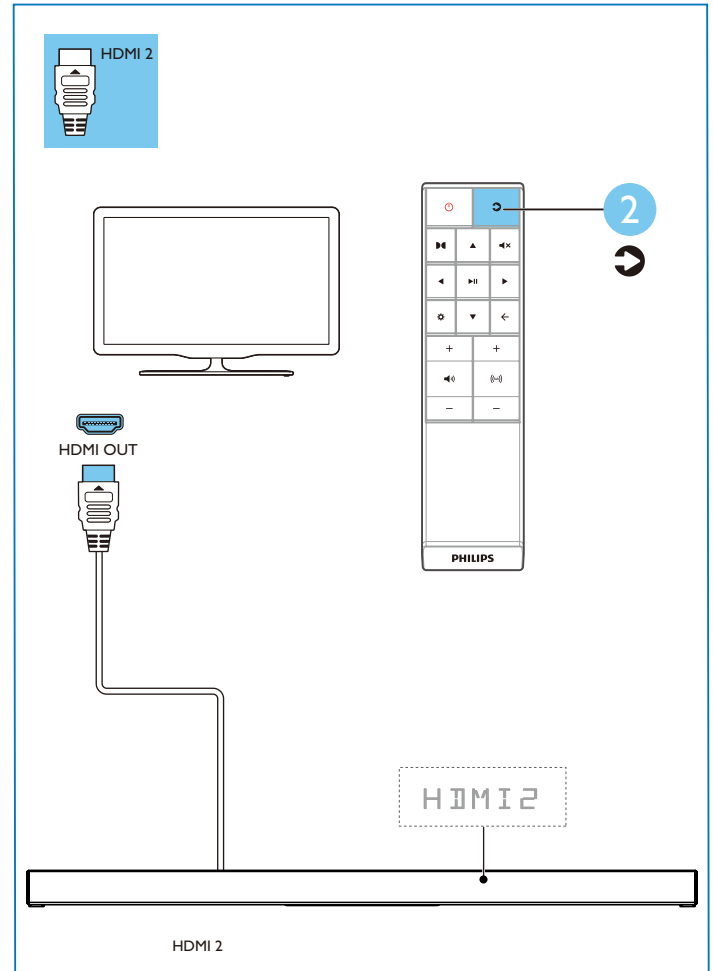
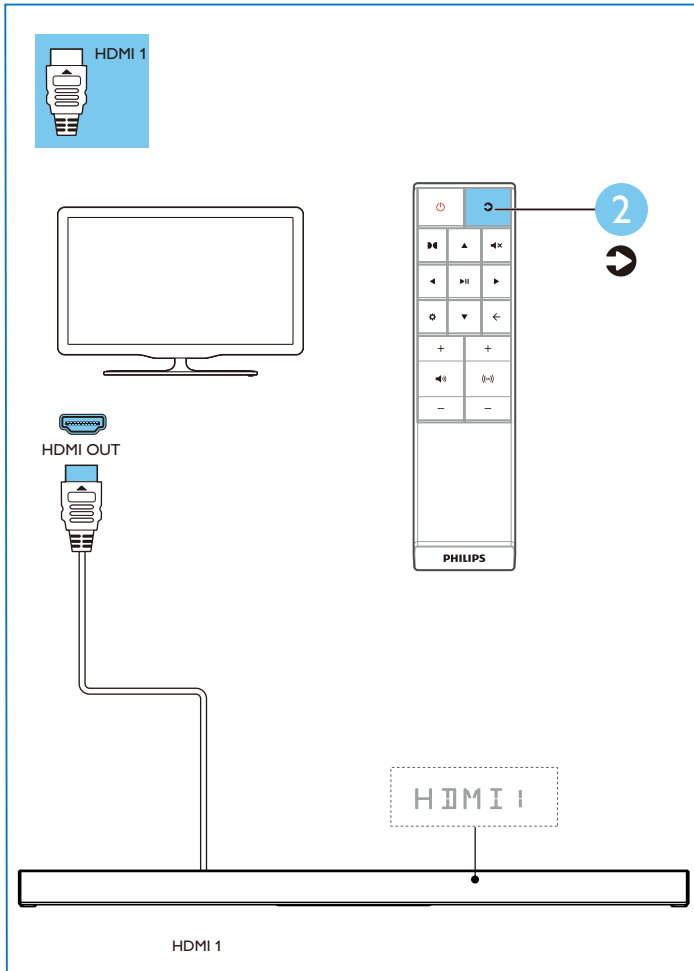

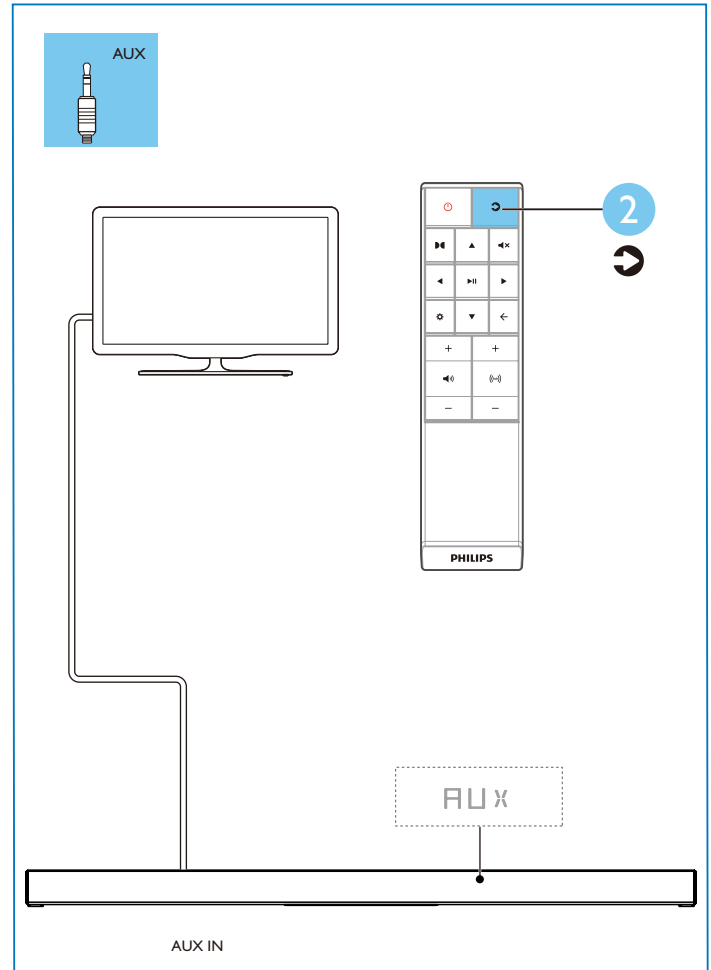
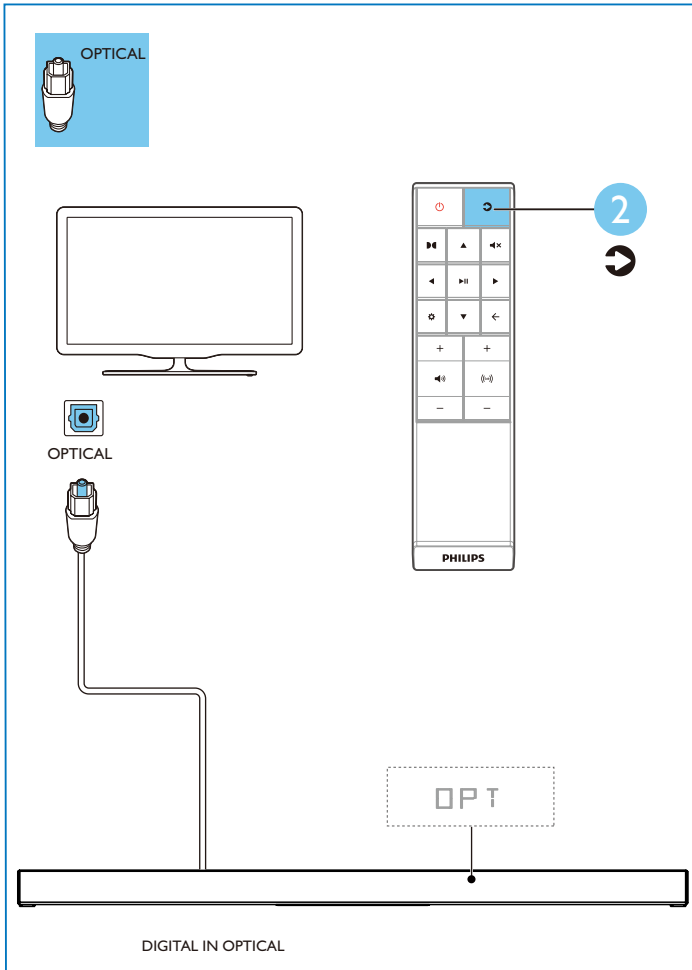

6

- EN** Play other devices
- SQ** Luani pajisje të tjera
- AR** تشغيل الأجهزة الأخرى
- BS** Reprodukujte druge uređaje
- BG** Включете други устройства
- HR** Pokrenite reprodukciju na drugom uređaju
- CS** Přehrávejte zařízení
- DA** Afspil andre enheder
- NL** Speel muziek af op andere apparaten
- ET** Esitage teistest seadmetest
- FI** Toista muita laitteita
- FR** Lecture d'autres appareils
- DE** Andere Geräte wiedergeben
- EL** Απαρραγωγή άλλων συσκευών
- HU** Lejátszás egyéb eszközökről
- IT** Riproduzione da altri dispositivi
- KK** Баска құрылғыларды ойнату
- LV** Atskaņojiet citas ierīces
- LT** Atkurkite garšą iš kitų įrenginių
- MK** Репродуцирајте на други уреди
- ME** Reprodukција drugih uređaja
- NO** Spill av fra andre enheter
- PL** Odtwarzaj z innych urządzeń
- PT** Reproduzir outros dispositivos
- RO** Redați alte dispozitive
- RU** Воспроизводите записи с других устройств.
- SR** Reprodukujte druge uređaje
- SK** Prehrávanie cez iné zariadenia
- SL** Predvajanje na drugih napravah
- ES** Reproducir otros dispositivos
- SV** Spela andra enheter
- TR** Diğer cihazları oynatın.
- UK** Відтворюйте медіа з інших пристроїв
- MS** Mainkan peranti yang lain
- ID** Putar perangkat lainnya

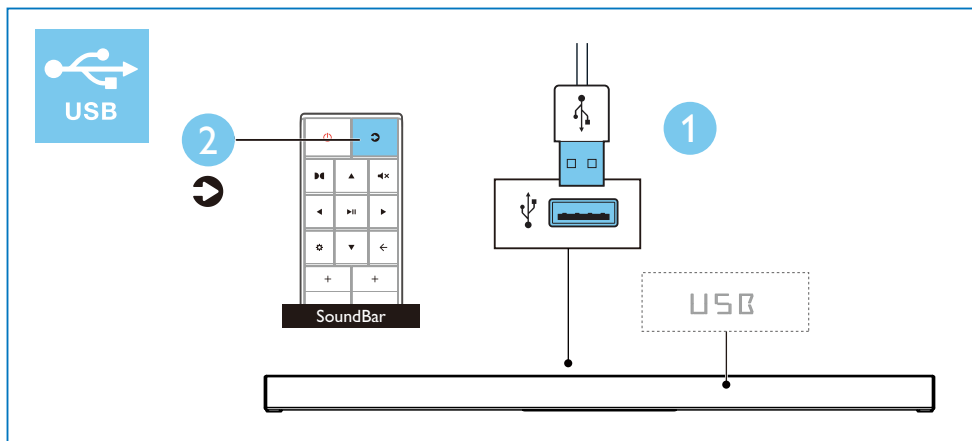
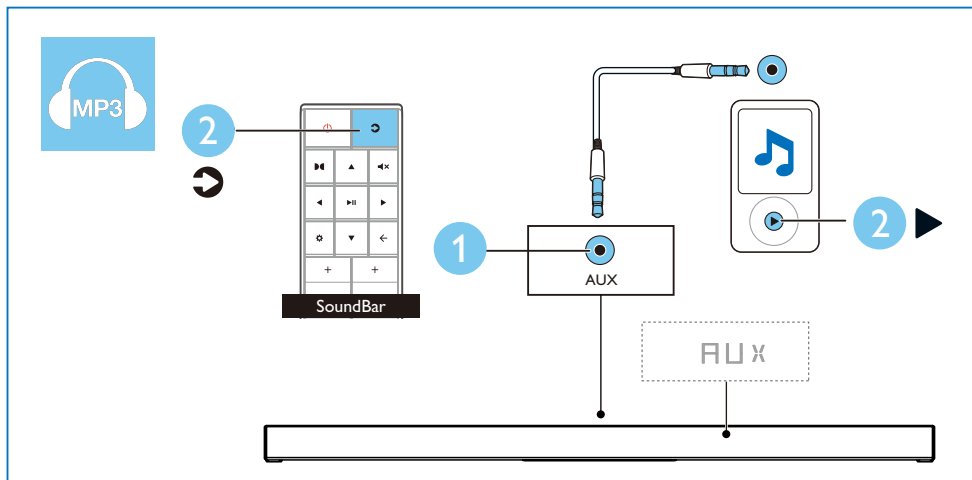

7

- EN** Play audio through Bluetooth
- SQ** Luani audio nëpërmjet Bluetooth
- AR** تشغيل الصوت من خلال البلوتوث
- BS** Reprodukujte zvuk putem Bluetootha
- BG** Възпроизвеждане на звук чрез Bluetooth
- HR** Reproducirajte putem Bluetootha
- CS** Přehrávání prostřednictvím Bluetooth
- DA** Afspil lyd via Bluetooth
- NL** Speel muziek af via Bluetooth
- ET** Esitage heli läbi Bluetoothi
- FI** Toista ääntä Bluetoothin välityksellä
- FR** Lecture de l'audio via Bluetooth
- DE** Audiowiedergabe über Bluetooth
- EL** Απαρραγωγή ήχου μέσω Bluetooth
- HU** Hang lejátszása Bluetooth-on keresztül
- IT** Riproduzione di audio tramite Bluetooth
- KK** Bluetooth аркымы аудионы ойнату
- LV** Atskaņojiet audio caur Bluetooth
- LT** Atkurkite garsą naudodamiesi „Bluetooth“
- MK** Репродуцирајте аудио преку Bluetooth
- ME** Reprodukција zvuka putem Bluetooth-a
- NO** Spill av lyd gjennom Bluetooth
- PL** Odtwarzaj dźwięk przez Bluetooth
- PT** Reproduzir áudio via Bluetooth
- RO** Redați audio prin Bluetooth
- RU** Воспроизводите аудиозаписи через Bluetooth.
- SR** Репродукујте звук путем Блутута
- SK** Prehrávanie zvuku cez Bluetooth
- SL** Predvajanje preko Bluetooth
- ES** Reproducir audio mediante Bluetooth
- SV** Spela ljud genom Bluetooth
- TR** Bluetooth aracılığıyla ses çalın.
- UK** Відтворюйте аудіо через Bluetooth
- MS** Mainkan audio melalui Bluetooth
- ID** Putar audio melalui Bluetooth



Bluetooth
Frequency band / Output power
2402-2480 MHz / ≤ 5 dBm

2
➡

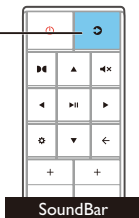

2



3

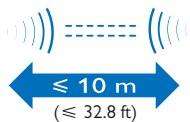

EN	Wi-Fi
SQ	Wi-Fi
AR	Wi-Fi
BS	Wi-Fi
BG	Wi-Fi
HR	Wi-Fi
CS	Wi-Fi
DA	Wi-Fi
NL	Wi-Fi
ET	Wi-Fi
FI	Wi-Fi
FR	Wi-Fi
DE	Wi-Fi
EL	Wi-Fi
HU	Wi-Fi
IT	Wi-Fi
KK	Wi-Fi
LV	Wi-Fi
LT	Wi-Fi
MK	Wi-Fi
ME	Wi-Fi
NO	Wi-Fi
PL	Wi-Fi
PT	Wi-Fi
RO	Wi-Fi
RU	Wi-Fi
SR	Wi-Fi
SK	Wi-Fi
SL	Wi-Fi
ES	Wi-Fi
SV	Wi-Fi
TR	Wi-Fi
UK	Wi-Fi
MS	Wi-Fi
ID	Wi-Fi



Network Supported
 WiFi IEEE 802.11a/b/g/n Wireless
 Frequency Band (Wi-Fi) :
 2.412 - 2.472GHz, 5.18 - 5.32GHz,
 5.50 - 5.70GHz, 5.745 – 5.825GHz

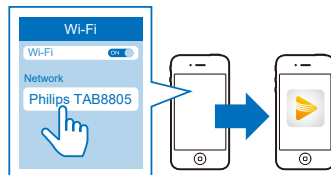

1

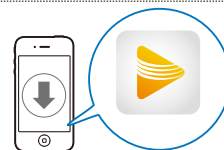

User install the Play-Fi app from app store.

2

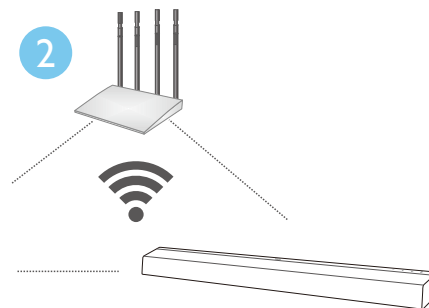

The app will guide user to enter user's home network SSID & password to connect the Soundbar to the home network

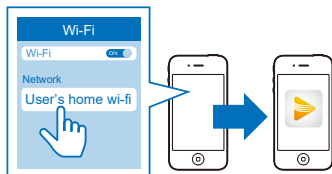

3

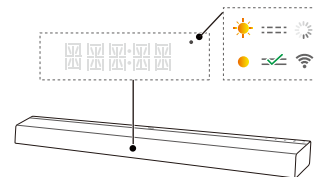

Play-Fi connect play is possible by connecting this unit to the same network as a smart phone or tablet. Depending on the streaming app used (e.g Play-Fi / Spotify / Google cast / AirPlay2), the user may need to register from their computer first. Refer to the websites for each of the services for details about them.



EN For more information about using this product, visit www.philips.com/support

BG За повече информация относно използването на този продукт, посетете www.philips.com/support

NL Kijk op www.philips.com/support voor informatie over het gebruik van dit product.

DE Weitere Informationen zur Verwendung dieses Produkts finden Sie unter www.philips.com/support

KK Осы өнімді пайдалану туралы қосымша ақпарат алу үшін www.philips.com/support бетіне кіріңіз

ME Za više informacija o korišćenju proizvoda, posjetite www.philips.com/support

RO Pentru mai multe informații despre utilizarea acestui produs, accesați www.philips.com/support

SL Za več informacij o tem izdelku, obiščite www.philips.com/support

MS Untuk maklumat lebih lanjut tentang cara menggunakan produk ini, layari www.philips.com/support

SQ Për më shumë informacion rreth përdorimit të këtij produkti, vizitoni www.philips.com/support

HR Za više informacija o korištenju ovog proizvoda posjetite www.philips.com/support

ET Lisateavet selle toote kohta leiate www.philips.com/support

EL Για περισσότερες πληροφορίες σχετικά με τη χρήση αυτού του προϊόντος, επισκεφθείτε τη διεύθυνση www.philips.com/support

LV Lai iegūtu papildinformāciju par šī produkta lietošanu, apmeklējiet vietni www.philips.com/support

NO Du finner mer informasjon om dette produktet på www.philips.com/support

RU Для получения дополнительной информации о данном изделии посетите веб-сайт www.philips.com/support.

ES Para obtener más información sobre el uso de este producto, visite www.philips.com/support

ID Untuk informasi lebih lanjut tentang produk ini, kunjungi www.philips.com/support

AR لمزيد من المعلومات حول استخدام هذا المنتج ، نفضل بزيارة www.philips.com/support

CS Další informace o tomto výrobku najdete na webu www.philips.com/support

FI Lisätietoja tämän tuotteen käytöstä, vieraile sivustolla www.philips.com/support

HU A termék használatával kapcsolatos további információért látogasson el a www.philips.com/support címre

LT Daugiau informacijos apie šio produkto naudojimą rasite apsilankę puslapyje www.philips.com/support

PL Aby uzyskać więcej informacji o obsłudze tego urządzenia, odwiedź stronę www.philips.com/support

SR Za više informacija o korišćenju ovog proizvoda idite na www.philips.com/support

SV För mer information om hur du använder denna produkt så besök www.philips.com/support

BS Za više informacija o korištenju ovog proizvoda idite na www.philips.com/support

DA For mere information om brugen af dette produkt, gå til www.philips.com/support

FR Pour plus d'informations sur l'utilisation de ce produit, visitez www.philips.com/support

IT Per ulteriori informazioni sull'utilizzo di questo prodotto, visitate il sito www.philips.com/support

MK Za povećane informacije za korišćenje na ovoj proizvod, posetite www.philips.com/support

PT Para obter mais informações sobre a utilização deste produto, visite www.philips.com/support.

SK Viac informáci o používaní produktu nájdete na stránke www.philips.com/support

TR Bu ürünün kullanımı hakkında daha fazla bilgi için www.philips.com/support adresini ziyaret edin.

UK Докладнішу інформацію про цей виріб шукайте на www.philips.com/support



The Wi-Fi CERTIFIED Logo is a certification mark of Wi-Fi Alliance®.

AirPlay, iPad, iPhone, iPod, iPod classic, iPod nano and iPod touch are trademarks of Apple Inc., registered in the U.S. and other countries.

The Spotify Software is subject to third party licenses found here: www.spotify.com/connect/third-party-licenses

Manufactured under license from Dolby Laboratories. Dolby, Dolby Atmos, Dolby Audio and the double-D symbol are trademarks of Dolby Laboratories.

The terms HDMI, HDMI High-Definition Multimedia Interface, and the HDMI Logo are trademarks or registered trademarks of HDMI Licensing Administrator, Inc.

The Bluetooth® word mark and logos are registered trademarks owned by Bluetooth SIG, Inc. and any use of such marks by MMD Hong Kong Holding Limited is under:



www.philips.com/support



Specifications are subject to change without notice. Please visit www.Philips.com/support for the latest updates and documents.

Philips and the Philips Shield Emblem are registered trademarks of Koninklijke Philips N.V. and are used under license.

This product has been manufactured by and is sold under the responsibility of MMD Hong Kong Holding Limited or one of its affiliates, and MMD Hong Kong Holding Limited is the warrantor in relation to this product.

